

外型尺寸 APPEARANCE SIZE

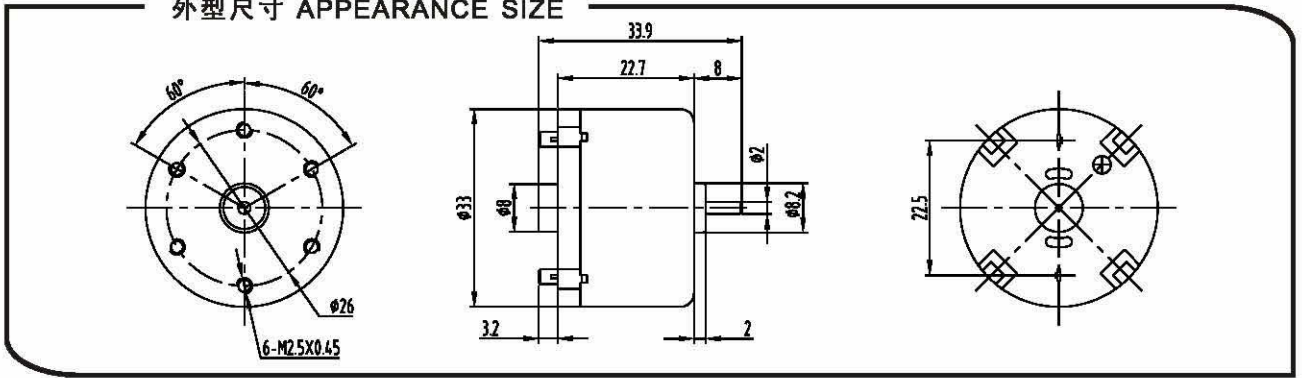

电机力矩/速度/电流 MOTOR TORQUE/SPEED/CURRENT

马达型号 Motor Model	电压 Rated Volt. V	空载 No load		最大效率点 At maximum efficiency				堵转 Stall torque	
		电流 Current mA	转速 Speed r/min	电流 Current mA	转速 Speed r/min	扭矩 Torque g.cm	输出功率 Power W	扭矩 Torque g.cm	电流 Current mA
PM-33123000	12	≤20	3000	≤110	2200	25	0.55	100	400
PM-33124500	12	≤30	4500	≤220	3300	35	1.2	140	850
PM-33126000	12	≤40	6000	≤410	4500	45	2.3	180	1400
PM-33243000	24	≤15	3000	≤60	2200	25	0.55	100	200
PM-33244500	24	≤20	4500	≤110	3300	35	1.2	140	420
PM-33246000	24	≤30	6000	≤200	4500	45	2.3	180	700

PM-33123000 特性曲线 CHARACTERISTICS

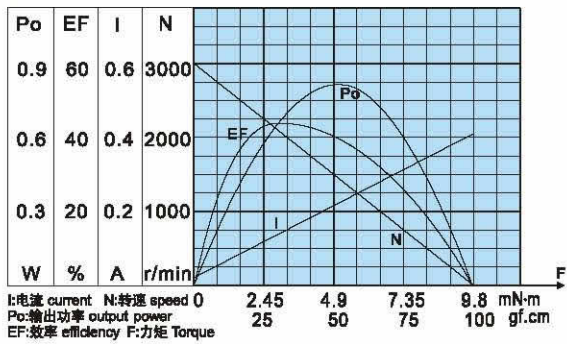

PM-33243000 特性曲线 CHARACTERISTICS

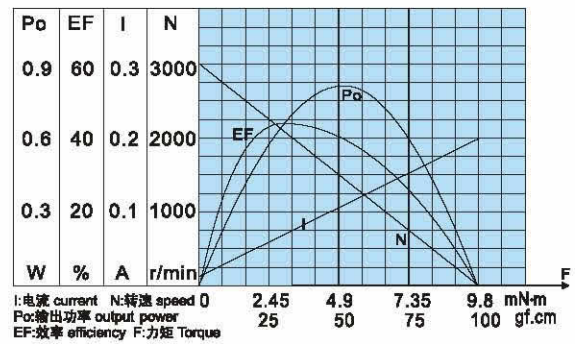

PM-33124500 特性曲线 CHARACTERISTICS

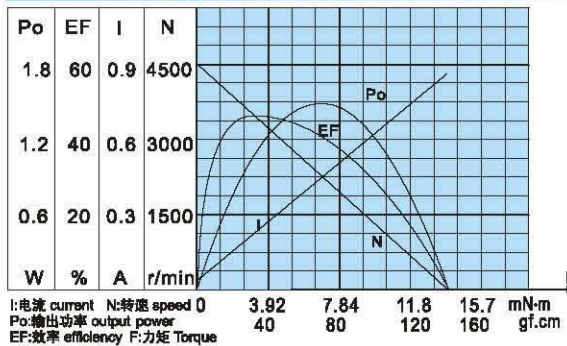

PM-33244500 特性曲线 CHARACTERISTICS

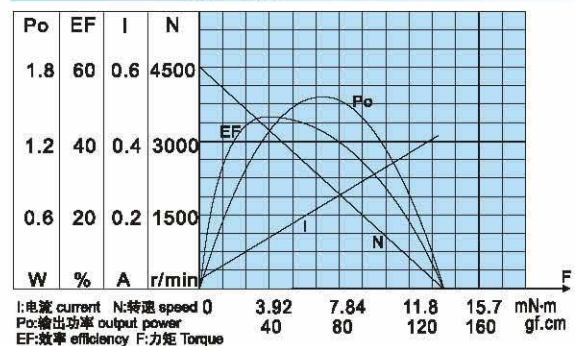

PM-33126000 特性曲线 CHARACTERISTICS

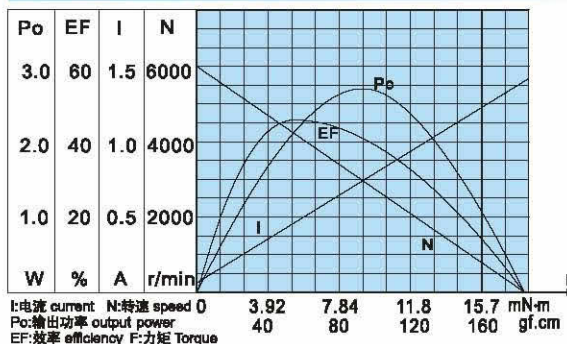

PM-33246000 特性曲线 CHARACTERISTICS

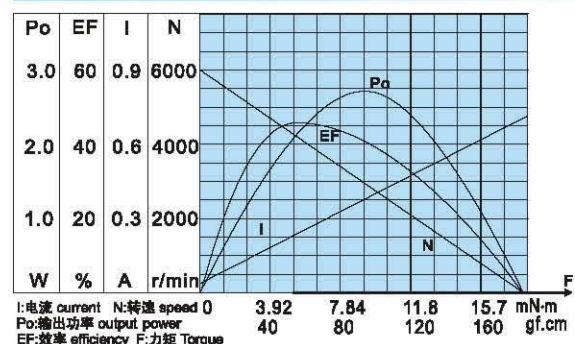

外型尺寸 APPEARANCE SIZE

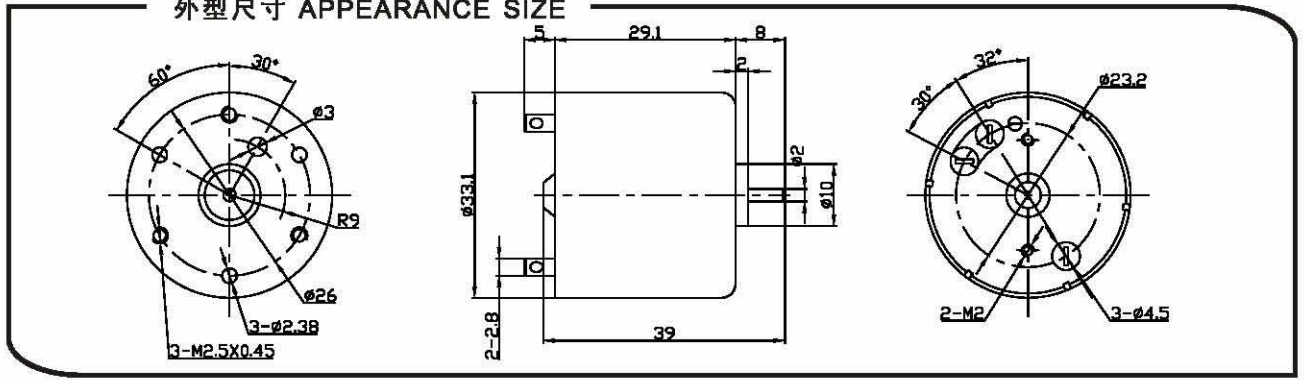

电机力矩/速度/电流 MOTOR TORQUE/SPEED/CURRENT

马达型号 Motor Model	电压 Rated Volt. V	空载 No load		最大效率点 At maximum efficiency				堵转 Stall torque	
		电流 Current mA	转速 Speed r/min	电流 Current mA	转速 Speed r/min	扭矩 Torque g. cm	输出功率 Power W	扭矩 Torque g. cm	电流 Current mA
TG-38123000	12	≤40	3000	≤180	2200	40	1.0	160	720
TG-38124500	12	≤50	4500	≤350	3300	60	2.0	210	1400
TG-38126000	12	≤70	6000	≤720	4500	80	3.6	300	2800
TG-38243000	24	≤15	3000	≤80	2200	40	0.9	140	320
TG-38244500	24	≤25	4500	≤180	3300	60	2.0	210	730
TG-38246000	24	≤45	6000	≤360	4500	80	3.6	300	1400

TG-38123000 特性曲线 CHARACTERISTICS

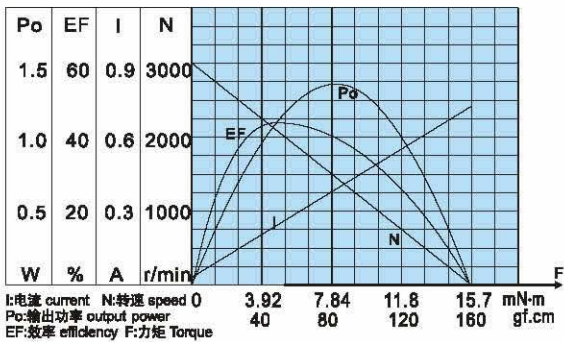

TG-38243000 特性曲线 CHARACTERISTICS

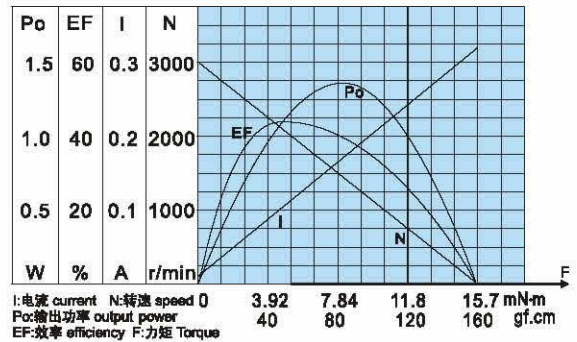

TG-38124500 特性曲线 CHARACTERISTICS

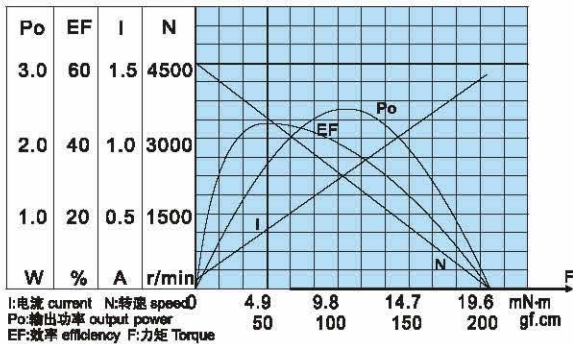

TG-38244500 特性曲线 CHARACTERISTICS

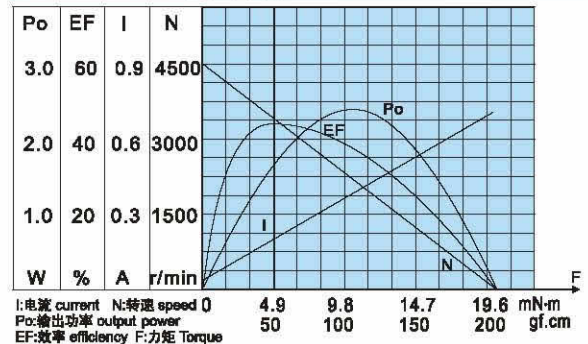

TG-38126000 特性曲线 CHARACTERISTICS

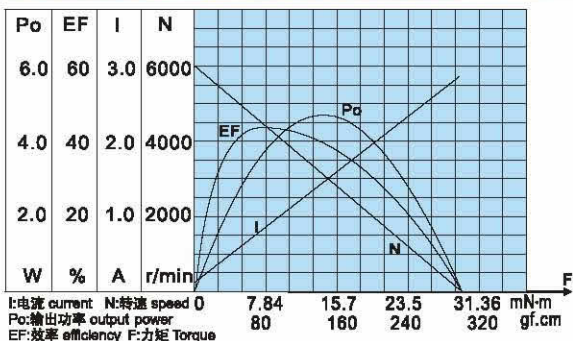

TG-38246000 特性曲线 CHARACTERISTICS

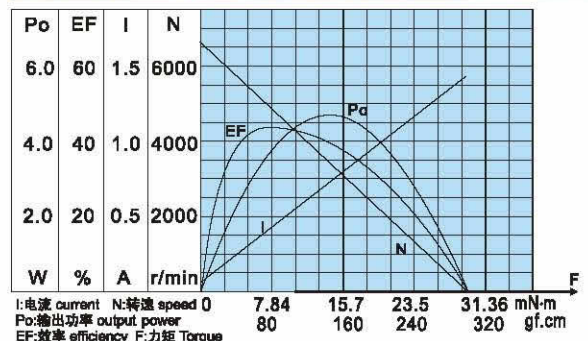

外型尺寸 APPEARANCE SIZE

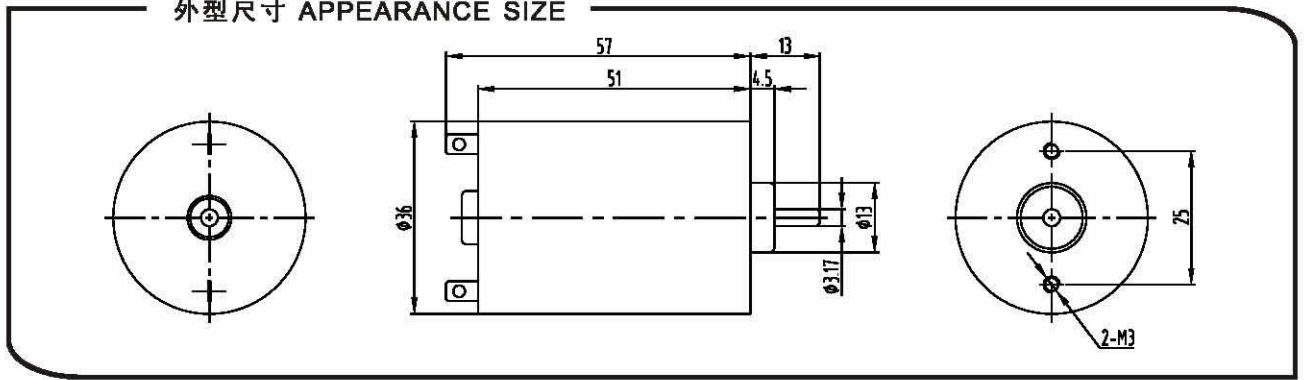

电机力矩/速度/电流 MOTOR TORQUE/SPEED/CURRENT

马达型号 Motor Model	电压 Rated Volt. V	空载 No load		最大效率点 At maximum efficiency				堵转 Stall torque	
		电流 Current mA	转速 Speed r/min	电流 Current mA	转速 Speed r/min	扭矩 Torque g.cm	输出功率 Power W	扭矩 Torque g.cm	电流 Current mA
RS-545123000	12	≤110	3000	≤450	2200	100	2.2	400	1800
RS-545124500	12	≤220	4500	≤800	3300	150	4.9	600	3000
RS-545126000	12	≤300	6000	≤1500	4500	200	9.0	800	5500
RS-545243000	24	≤60	3000	≤230	2200	100	2.2	400	900
RS-545244500	24	≤110	4500	≤400	3300	150	4.9	600	1500
RS-545246000	24	≤150	6000	≤750	4500	200	9.0	800	3000

RS-545123000 特性曲线 CHARACTERISTICS

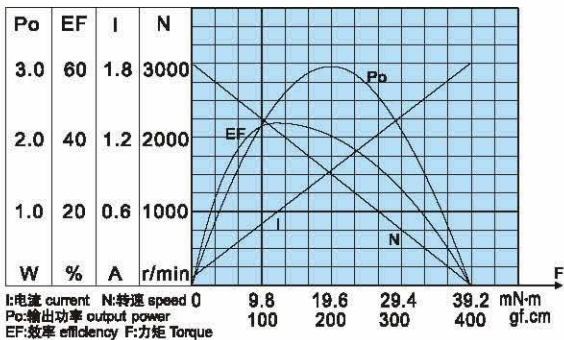

RS-545243000 特性曲线 CHARACTERISTICS

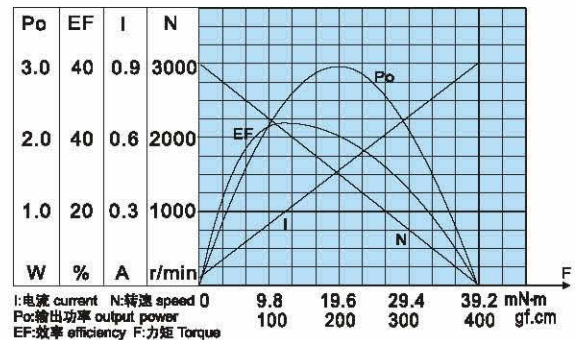

RS-545124500 特性曲线 CHARACTERISTICS

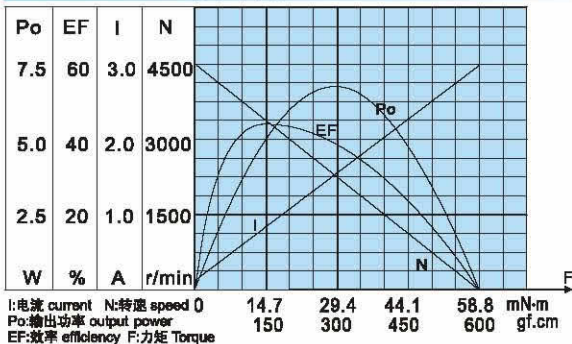

RS-545244500 特性曲线 CHARACTERISTICS

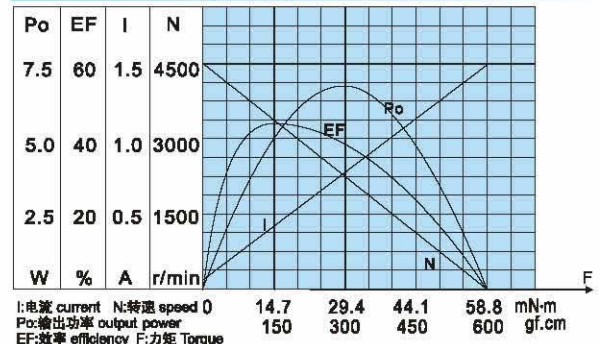

RS-545126000 特性曲线 CHARACTERISTICS

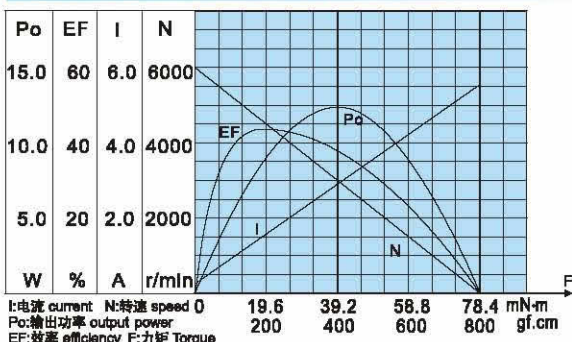

RS-545246000 特性曲线 CHARACTERISTICS

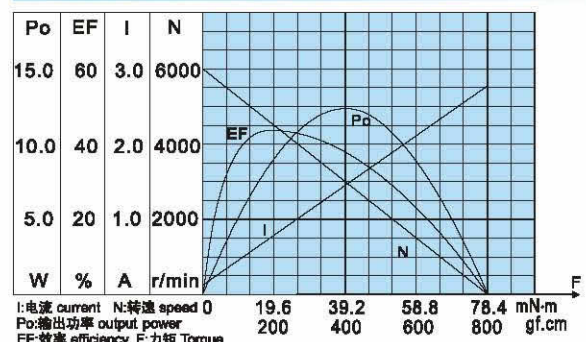

外型尺寸 APPEARANCE SIZE

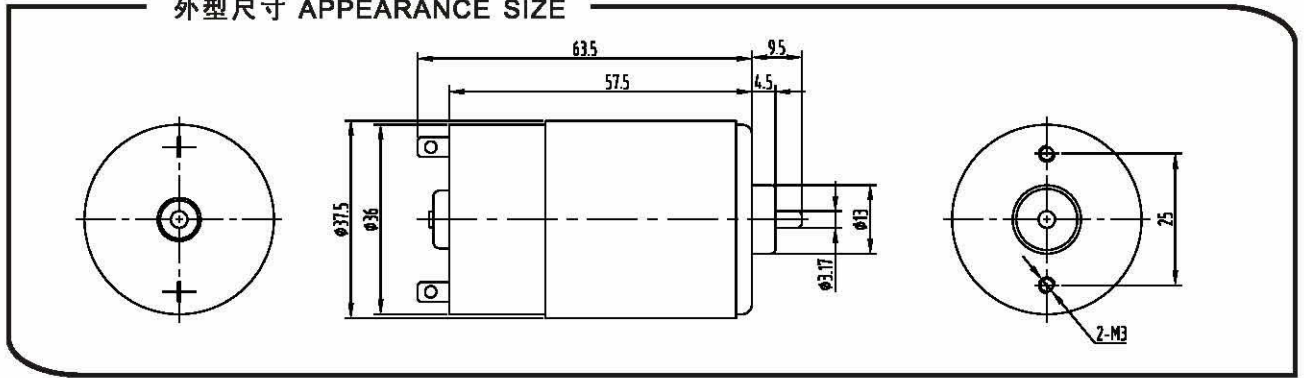

电机力矩/速度/电流 MOTOR TORQUE/SPEED/CURRENT

马达型号 Motor Model	电压 Rated Volt. V	空载 No load		最大效率点 At maximum efficiency				堵转 Stall torque	
		电流 Current mA	转速 Speed r/min	电流 Current mA	转速 Speed r/min	扭矩 Torque g. cm	输出功率 Power W	扭矩 Torque g. cm	电流 Current mA
RS-555123000	12	≤60	3000	≤250	2200	65	1.4	260	800
RS-555124500	12	≤90	4500	≤430	3300	80	2.6	320	1400
RS-555126000	12	≤130	6000	≤750	4500	105	4.7	420	2600
RS-555243000	24	≤40	3000	≤120	2200	65	1.4	260	400
RS-555244500	24	≤50	4500	≤220	3300	80	2.6	320	700
RS-555246000	24	≤70	6000	≤380	4500	105	4.7	420	1400

RS-555123000 特性曲线 CHARACTERISTICS

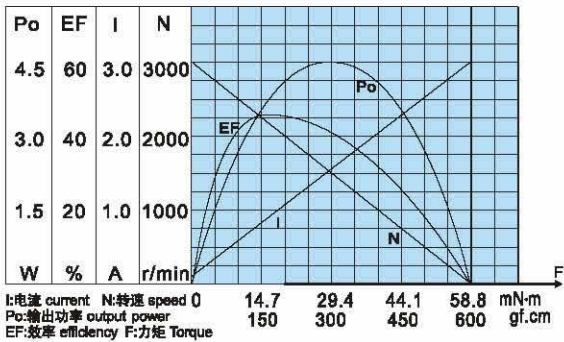

RS-555243000 特性曲线 CHARACTERISTICS

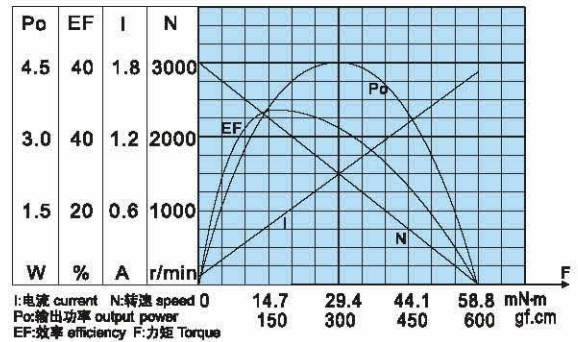

RS-555124500 特性曲线 CHARACTERISTICS

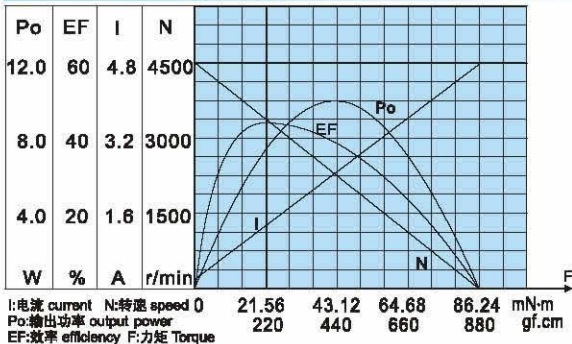

RS-555244500 特性曲线 CHARACTERISTICS

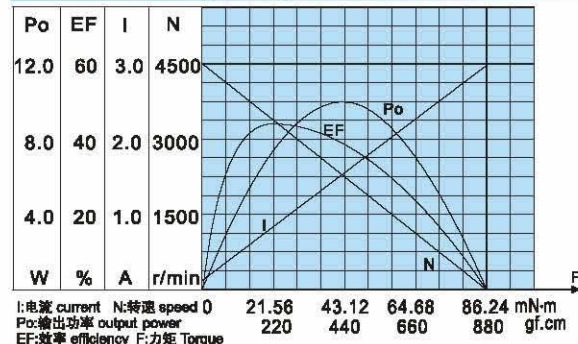

RS-555126000 特性曲线 CHARACTERISTICS

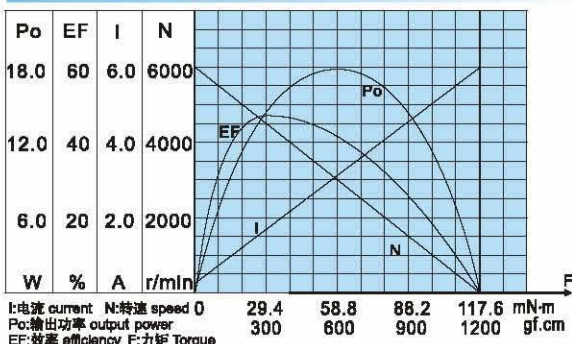

RS-555246000 特性曲线 CHARACTERISTICS

